



Ledinaire SlimDownlight DN065B

DN065B LED10S/830 PSU II WH

LED Module, system flux 1000 lm - 830 warm white - Power supply unit - Safety class II - White

The LEDINAIRE range contains a selection of popular off-the-shelf LED luminaires that come with the high Philips quality levels at a competitive price. Reliable, energy-efficient and affordable – just what you need

Product data

General Information			
Number of light sources	1 pc	Flammability mark	-
Lamp family code	LED10S [LED Module, system flux 1000 lm]	CE mark	CE mark
Beam angle of light source	90 x 90 °	ENEC mark	-
Light source color	830 warm white	Warranty period	3 years
Light source replaceable	No	Remarks	*-Per Lighting Europe guidance paper "Evaluating performance of LED based luminaires - January 2018": statistically there is no relevant difference in lumen maintenance between B50 and for example B10. Therefore the median useful life (B50) value also represents the B10 value.
Number of gear units	1 unit	Constant light output	No
Driver/power unit/transformer	Power supply unit	Number of products on MCB of 16 A type	48
Driver included	Yes	B	
Optic type	Wide beam	RoHS mark	RoHS mark
Luminaire light beam spread	90° x 90°		
Connection	Screw connector		
Cable	-		
Protection class IEC	Safety class II		
Glow-wire test	Temperature 650 °C, duration 5 s		

Ledinaire SlimDownlight DN065B

Unified glare rating CEN	Not applicable
--------------------------	----------------

Operating and Electrical

Input Voltage	220 to 240 V
Input Frequency	50 to 60 Hz
Inrush current	4.03 A
Inrush time	272 ms
Power Factor (Min)	0.8

Controls and Dimming

Dimmable	No
----------	----

Mechanical and Housing

Housing Material	Aluminum
Reflector material	-
Optic material	Polycarbonate
Optical cover/lens material	Polycarbonate
Fixation material	Stainless steel
Optical cover/lens finish	Frosted
Overall height	30 mm
Overall diameter	175 mm

Approval and Application

Ingress protection code	IP20 [Finger-protected]
Mech. impact protection code	IK02 [0.2 J standard]

Initial Performance (IEC Compliant)

Initial luminous flux (system flux)	950 lm
Luminous flux tolerance	+/-10%
Initial LED luminaire efficacy	86 lm/W

Init. Corr. Color Temperature	3000 K
Init. Color Rendering Index	>80
Initial chromaticity	(0.42, 0.40) SDCM <5
Initial input power	11 W
Power consumption tolerance	+/-10%

Over Time Performance (IEC Compliant)

Control gear failure rate at median useful life 50000 h	7.5 %
Lumen maintenance at median useful life* 50000 h	L65

Application Conditions

Ambient temperature range	0 to +35 °C
Performance ambient temperature Tq	25 °C
Suitable for random switching	No

Product Data

Full product code	871869938175299
Order product name	DN065B LED10S/830 PSU II WH
EAN/UPC - Product	8718699381752
Order code	910503910331
Numerator - Quantity Per Pack	1
Numerator - Packs per outer box	12
Material Nr. (12NC)	910503910331
Net Weight (Piece)	0.270 kg

Dimensional drawing

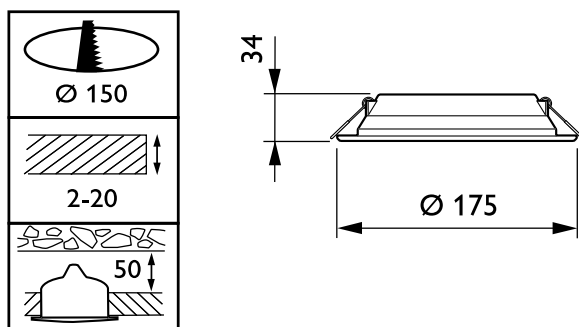

Ledinaire SlimDownlight DN065B

Ledinaire SlimDownlight DN065B

