

R-BOX 382R-11



PG21

ABS

IP44



1

PN-EN 61439-1, PN-EN 61439-3



B.18.382-1

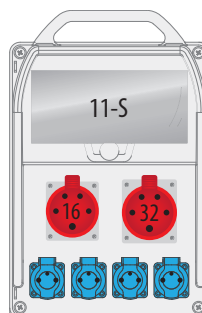

B.18.382-2



B.18.382-3



B.18.382-4

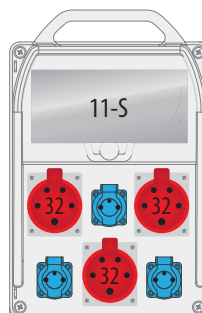

B.18.382-45

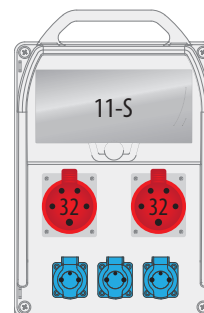

B.18.382-6



B.18.382-7

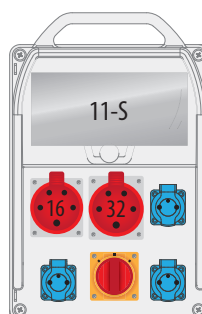

B.18.382-8W



B.18.382-9

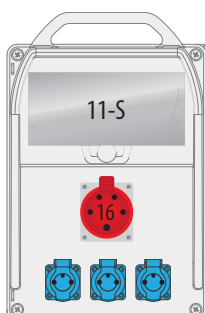

B.18.382-10

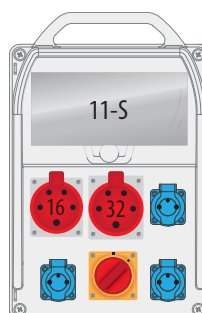

B.18.382-11W

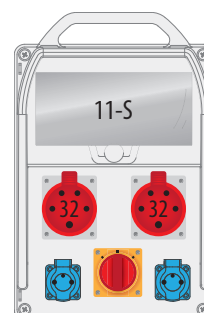

B.18.382-12W

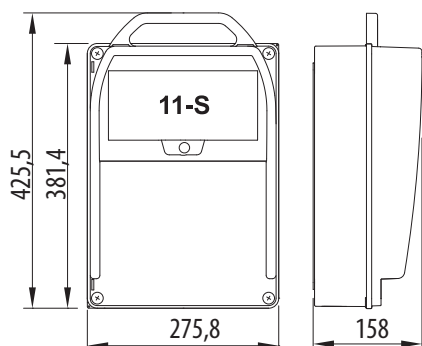

Wszystkie rozdzielnice na życzenie klienta wykonujemy w dowolnych możliwych konfiguracjach.

Rozdzielnice Serii R-BOX zawierają w komplecie odpowiedni dławik PG