

UCHWYTY NA DRUT wkręcany

C192332



WERSJA MATERIAŁOWA:

stal ocynkowana ogniowo

OPIS:

Uchwyt wkręcany do prowadzenia przewodu odgromowego po elewacji, konstrukcjach drewnianych.

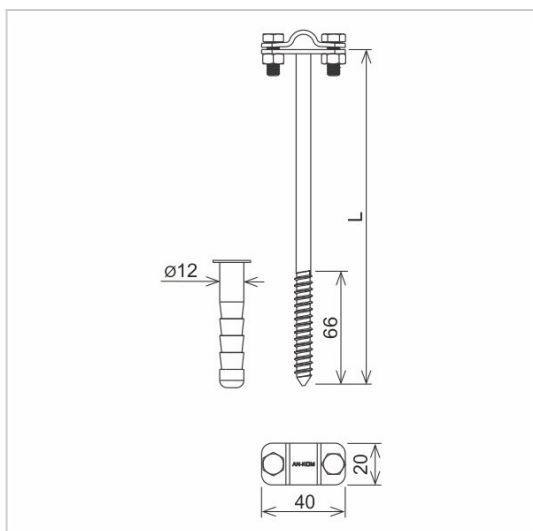

symbol	C192332
typ	AN-41/OG/
L (mm)	160
wymiar przewodu (mm)	Ø8
wersja materiałowa	stal ocynkowana ogniowo

