

Styczniki z modułem styków pomocniczych

DILM7...DILM15

DILA...

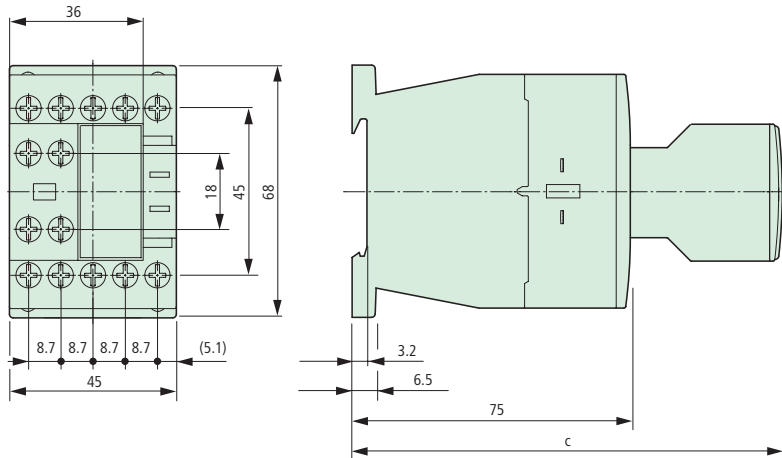

Typ	c
DILM32-XHI	117
DILA-XHI	117
DILA-XHI...T	125

DILMC7...DILMC12DILAC...

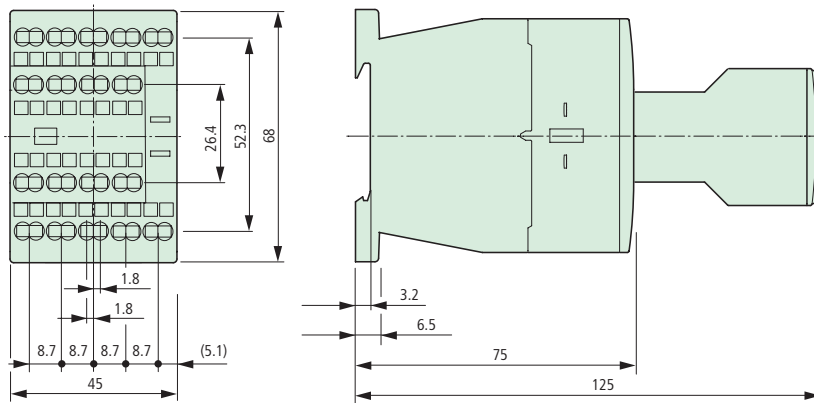

DILM17...DILM32DILMC17...DILMC32

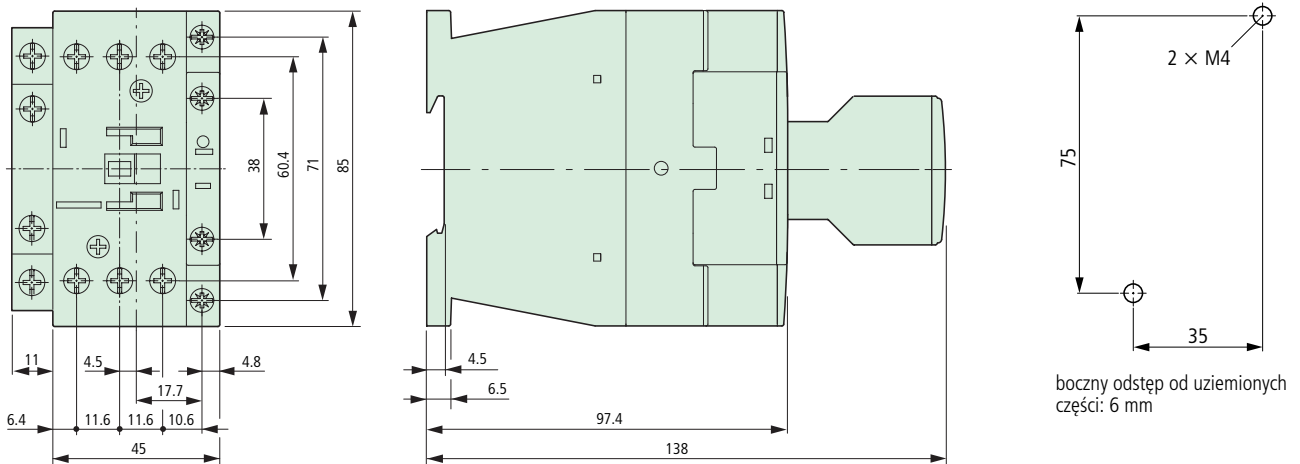

Styczniki

DILM40...DILM72DILMC40...DILMC65

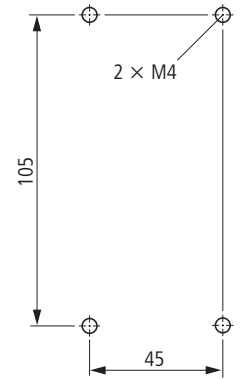
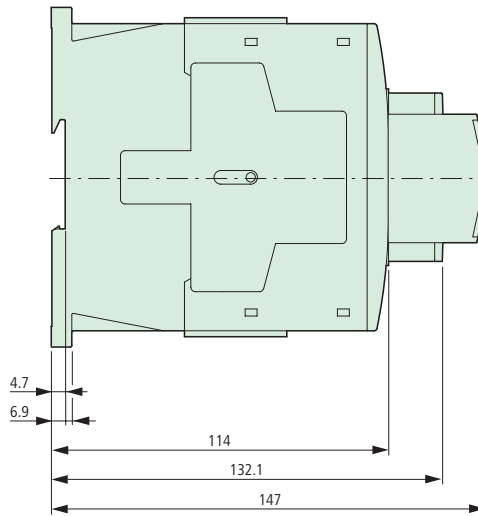
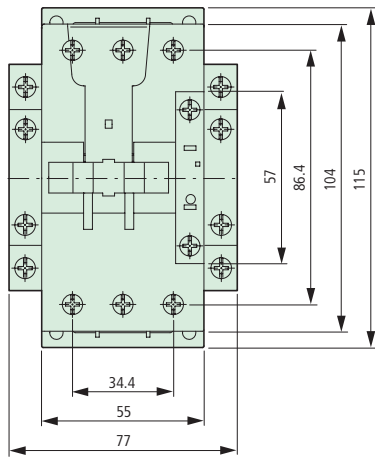

boczny odstęp od uziemionych części: 6 mm

DILM80...DILM170DILMC80...DILMC150

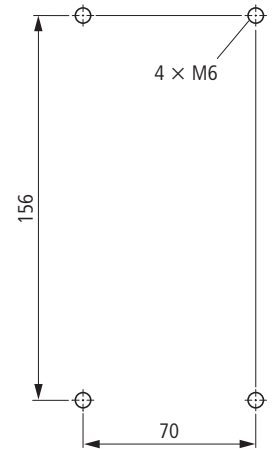
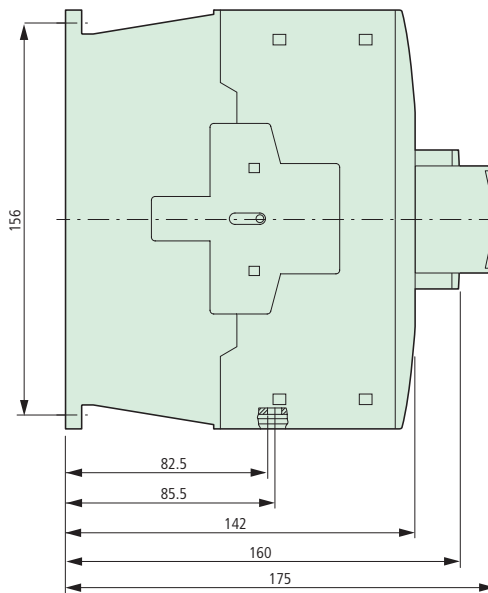
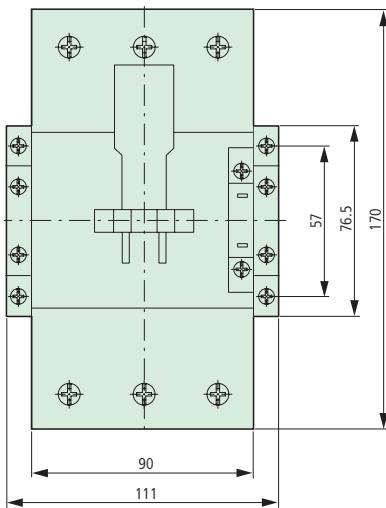

boczny odstęp od uziemionych części: 10 mm

Styczniki



Układy ochronne

DILM...XSP...

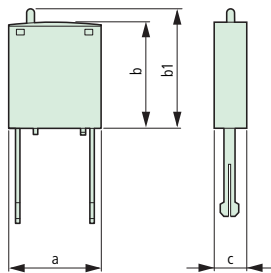

Typ	a	b	b1	c
DILM12-XSP...	25	28	≈ 32	9
DILM32-XSP...	25	28	≈ 32	9
DILM95-XSP...	25	28	≈ 32	9

Zestawy kompletne

DILM185...DILM500
DILMC185-S...DILMC500-S
DILM185-S...DILM500-S

- ① DILM1000-XHI...-SI
② DILM1000-XHI11-SA

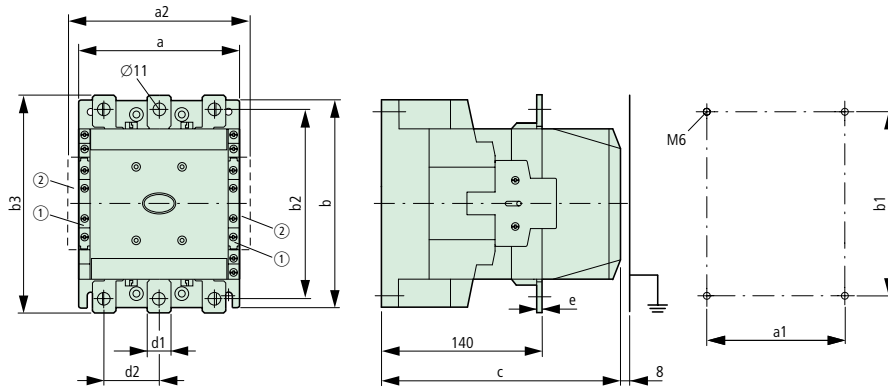

Typ	a	a1	a2	b	b1	b2	b3	d1	d2	e	c
DILM185	140	120	160	180	160	164	189	20	48	5	208
DILM225	140	120	160	180	160	164	189	20	48	5	208
DILM250	140	120	160	180	160	164	189	25	48	5	208
DILM300	160	130	180	200	180	184	209	25	48	6	216
DILM400	160	130	180	200	180	184	209	25	48	6	216
DILM500	160	130	180	200	180	189	219	38	57	6	216

DILM580...DILM1000

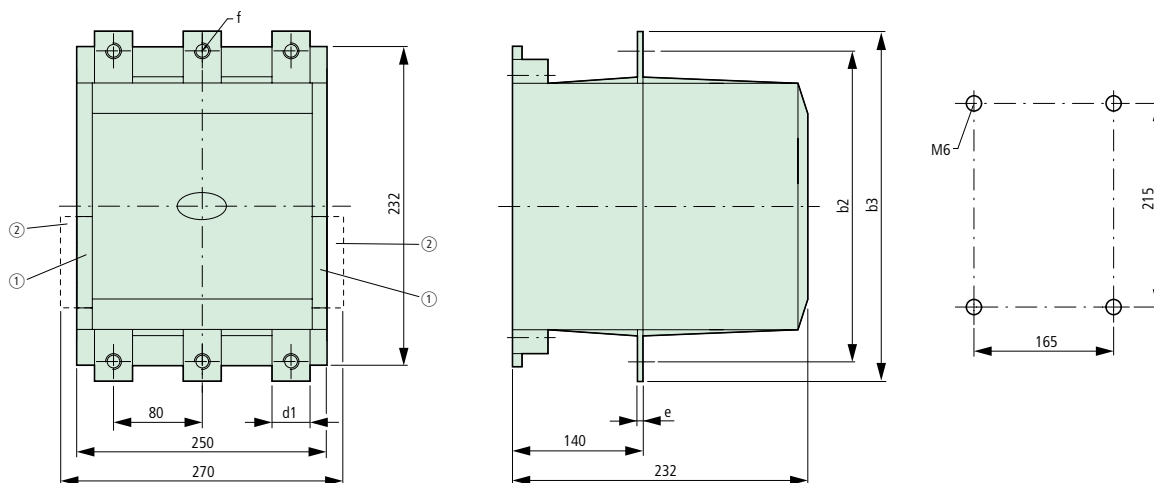

- ① DILM1000-XHI...-SI
② DILM1000-XHI11-SA

Typ	b2	b3	d1	e	f
DILM580	256	286	35	6	11
DILM650	256	286	35	6	11
DILM750	256	296	45	6	13.5
DILM820	256	296	45	6	13.5
DILM1000	256	296	45	10	13.5



Styczniki powyżej 1000 A, AC-1

DILH1400

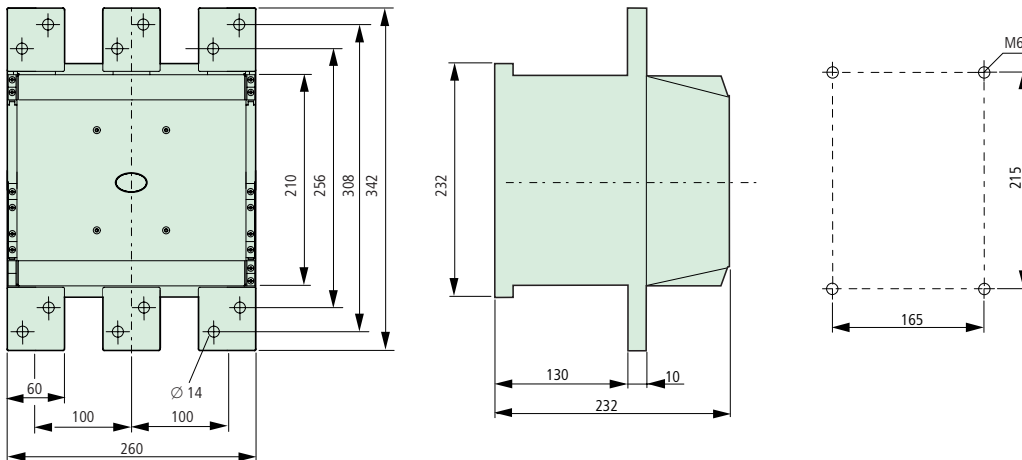

DILM1600

DILH2000

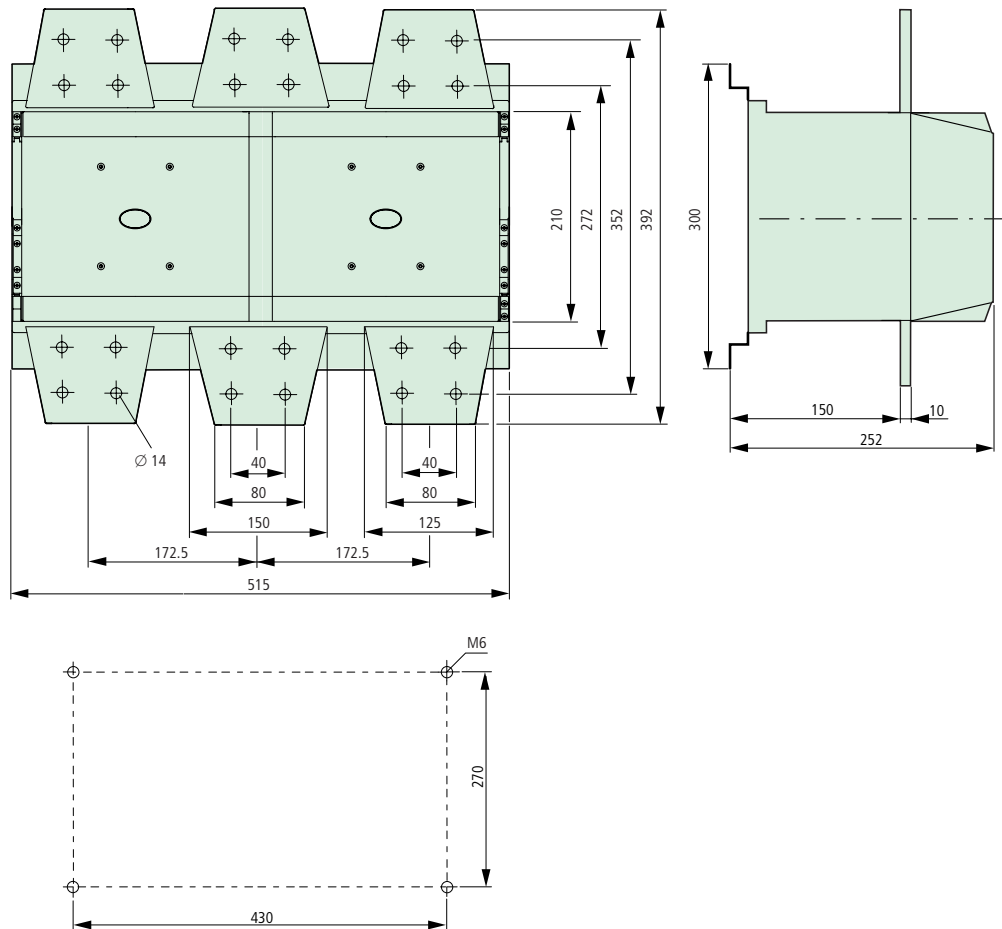

Styczniki nawrotne

DIULM80...DIULM150

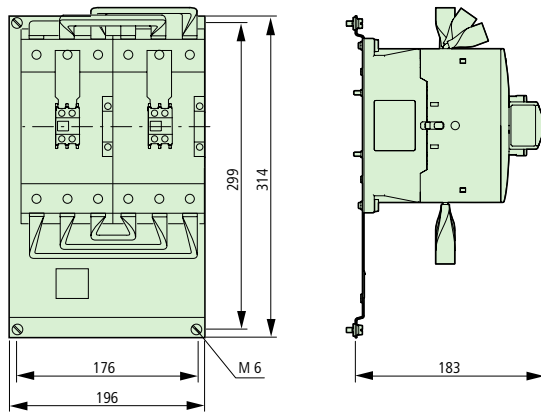

Bloki mostków trójfazowych

DILM12-XDSB...

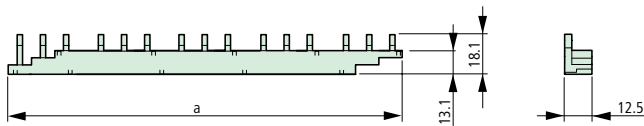

Typ	a
DILM12-XDSB0/3	112
DILM12-XDSB0/4	157
DILM12-XDSB0/5	202

Moduł wzmacniający

ETS4-VS3

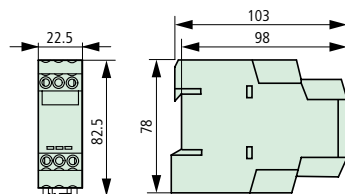

Elektroniczne moduły czasowe

DILM...XTE

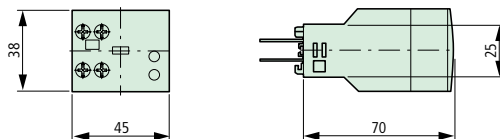

Styczniki mocy z osłoną zacisków

DILM185...250 + Z5-.../FF250

DILM185...DILM1000 + DILM...-XHB

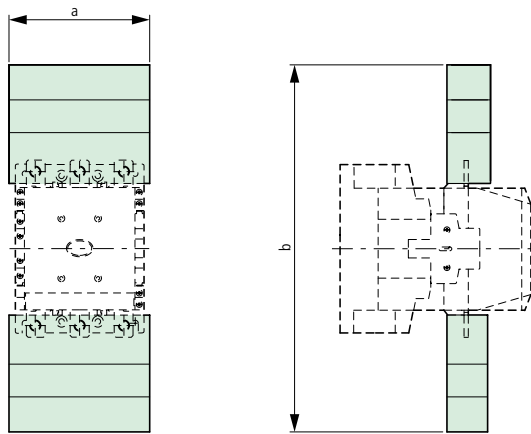

dla typu	a	b
DILM185...250	150	384
DILM300...400	150	404
DILM500	174	426
DILM580...1000	236	506

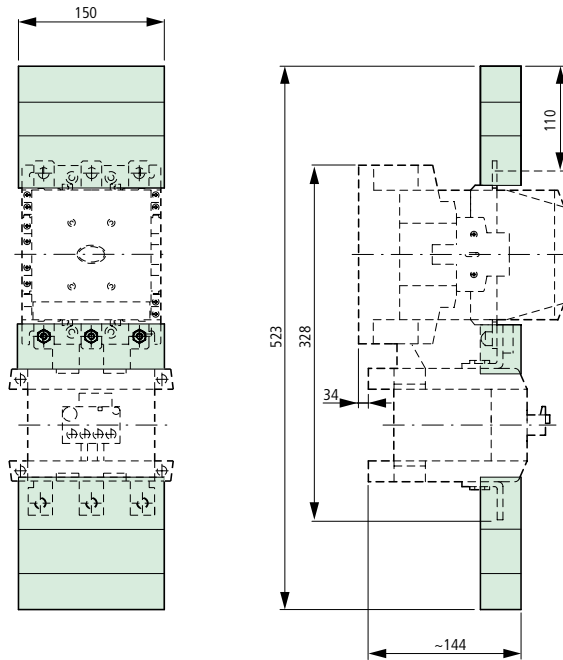

Styczniki mocy ze zworą punktu gwiazdowego i osłoną zacisków

DILM...XS1

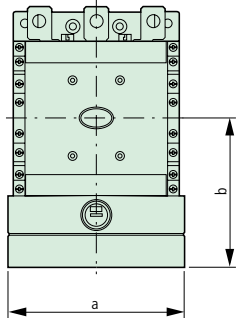

dla typu	a	b
DILM185...250	150	127
DILM300...400	150	137
DILM500	176	146

Blokada mechaniczna

DILM500-XMV

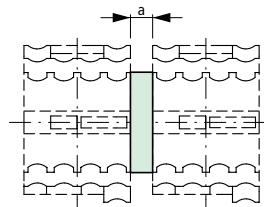

dla typu	a
DILM185...500	15

DILM820-XMV

